

Varenummer: 2310431051S
Beskrivelse: E+G Stilleben
LX.30-SW17-M6X24-S

Mål

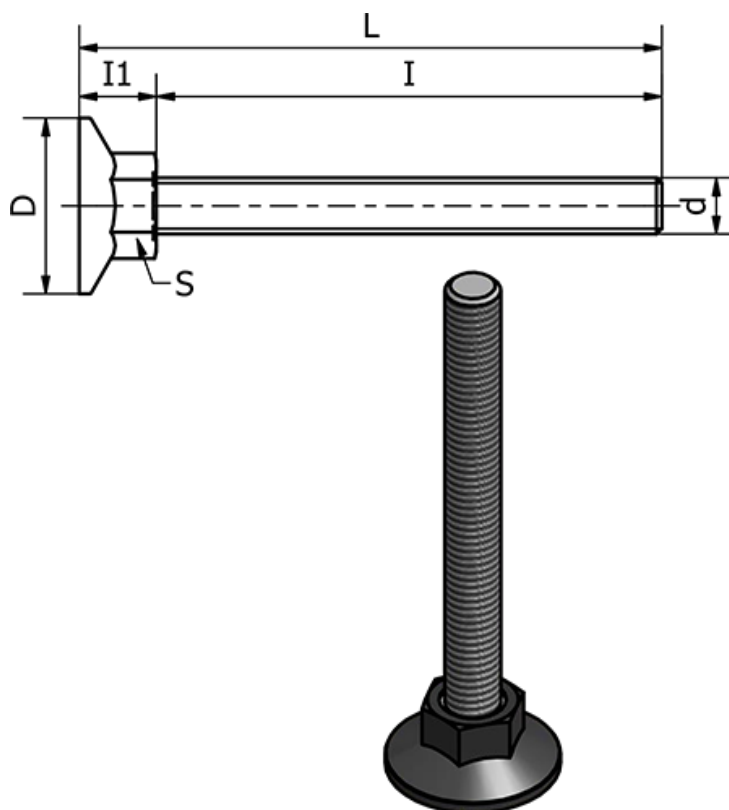

d	= M6
D	= 30
I	= 24
I1	= 12
L	= 36
Max statisk belastning (N)	= 1500
S	= 17
Type	= Forzinket

Vægt (g) = -